

PRO4848 4'x4' CNC Machine Kit (Top Down View)

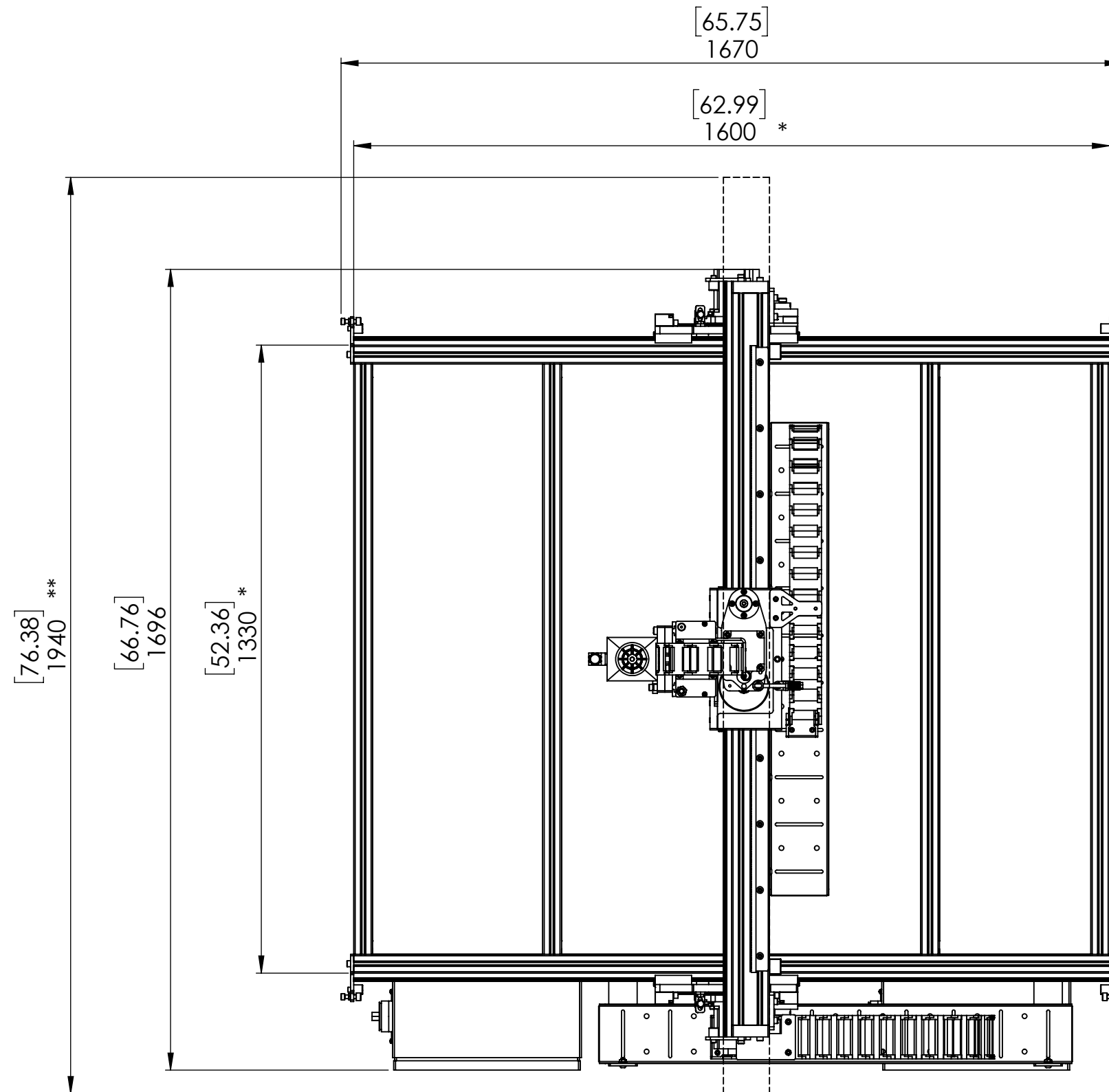

* Dimension to outside edges of extrusion, use this measurement if building your own leg assembly
** Extended Gantry Option

PRO CNC Machine

8" Z-Axis Travel / 8" Gantry Height

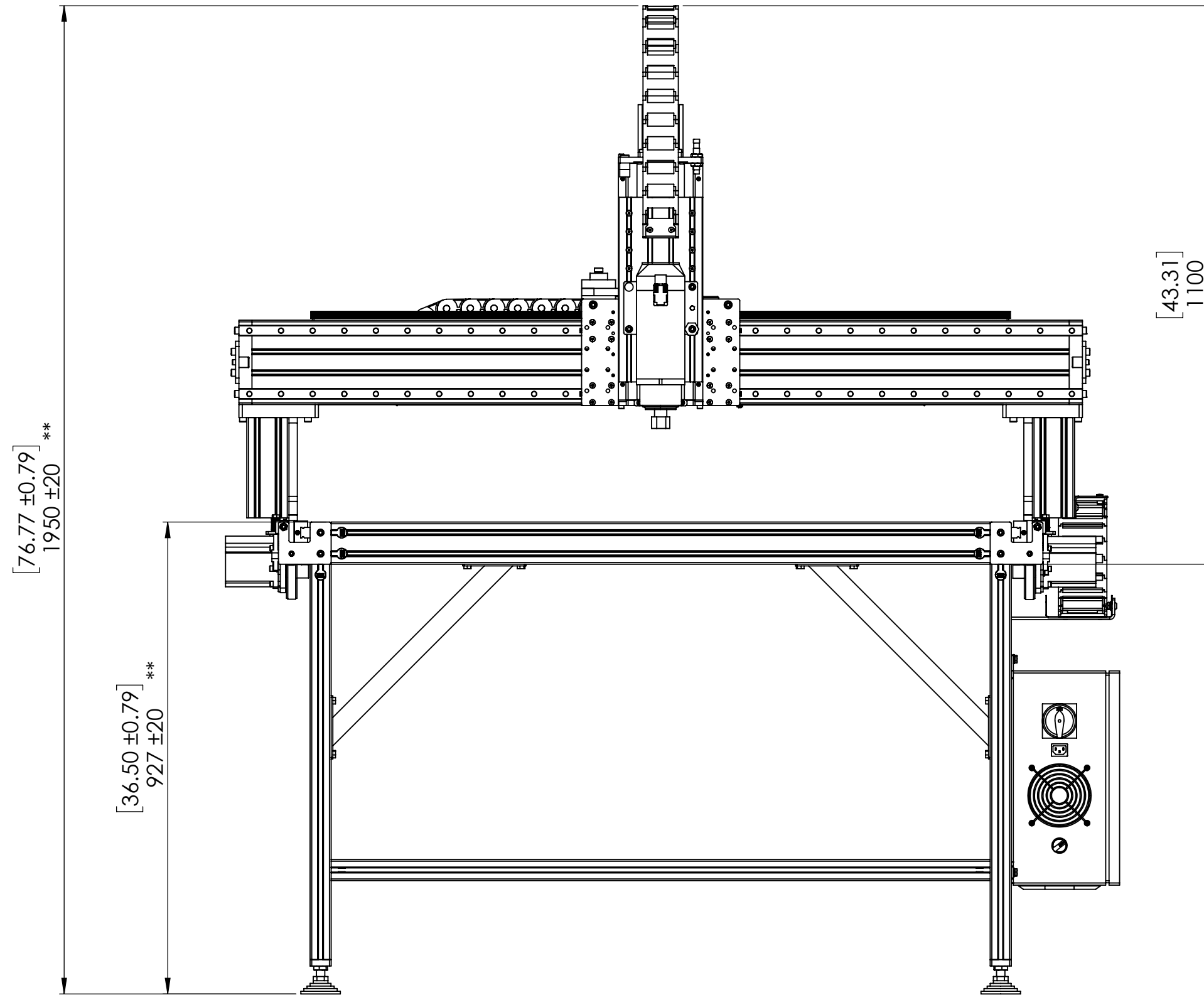

Updated 1/28/2019

**Adjustment of leveling feet in leg kit will impact actual height dimensions

Dimensions: [in]
mm



PRO CNC Machine 12" Z-Axis Travel / 8" Gantry Height

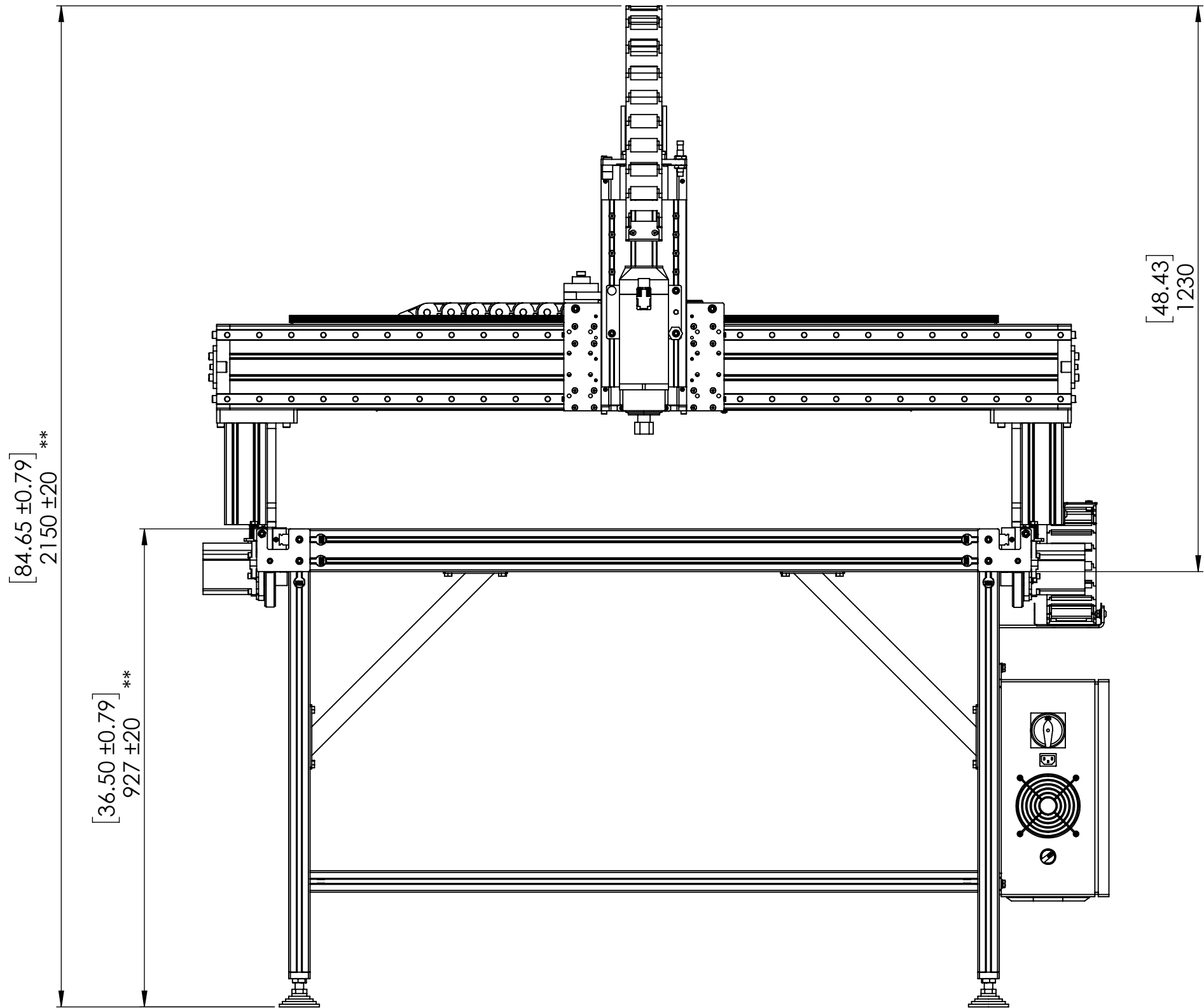

Updated 1/28/2019

**Adjustment of leveling feet in leg kit will impact actual height dimensions

Dimensions: [in]
mm



PRO CNC Machine 12" Z-Axis Travel / 12" Gantry Height

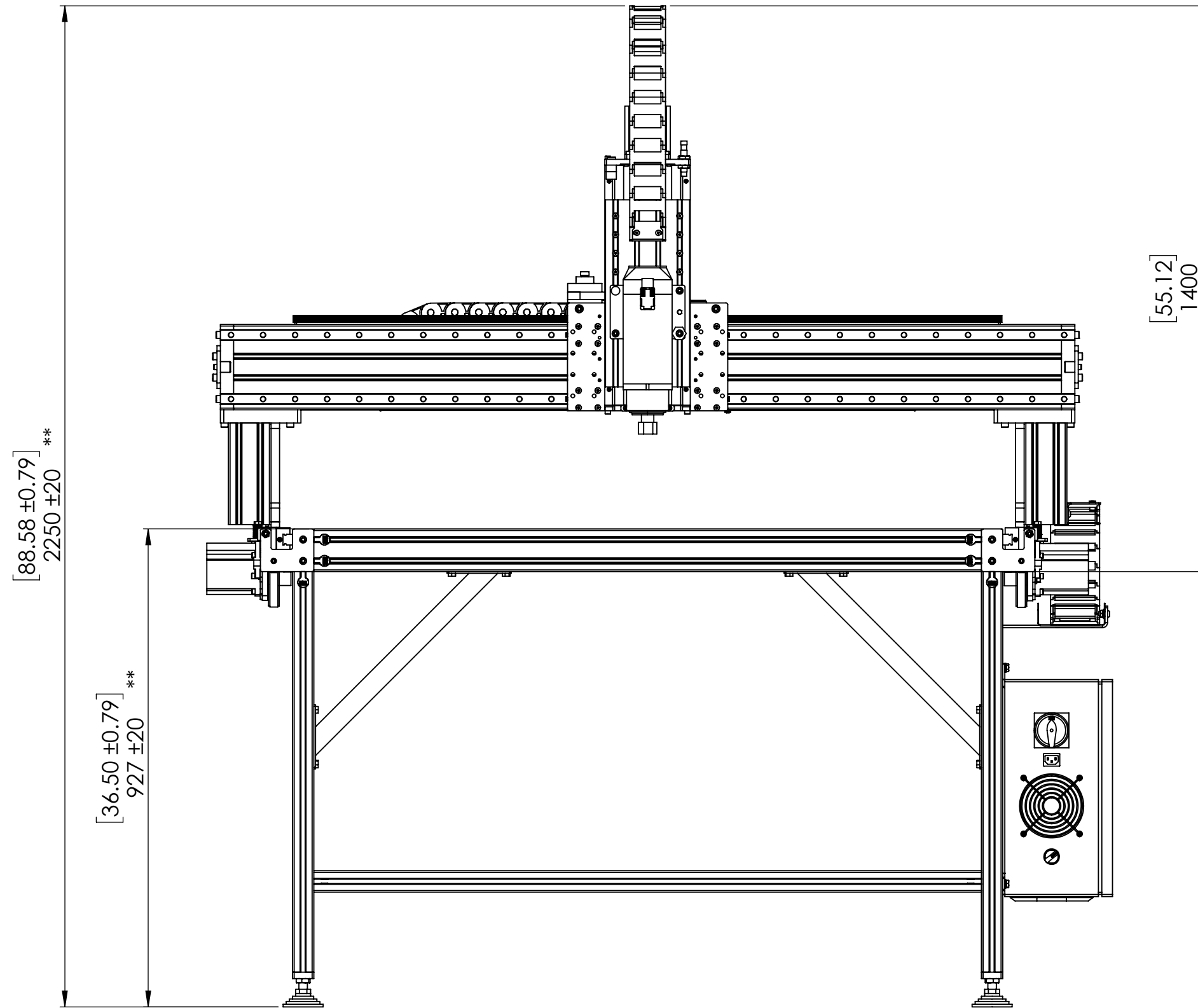

Updated 1/28/2019

**Adjustment of leveling feet in leg kit will impact actual height dimensions

Dimensions: [in]
mm

